

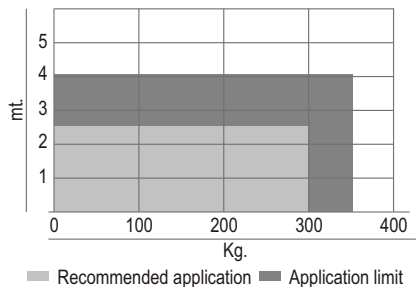

ART

Technical data	ART5000	ART5012	ART5024
use	residential	heavy	heavy
frequency of use	30%	40%	40%
motor power supply	● 230 Vac - 50/60 Hz	● 12 Vdc	● 24 Vdc
maximum power absorbed	200W	100W	100W
degree of protection	IP53	IP53	IP53
shaft rotation speed	7,8°/sec	7,6°/sec	5,6°/sec
maximum torque	250 Nm	220 Nm	220 Nm
maximum leaf length	3 m	3 m	3 m
operating temperature	-20° C +60° C	-20° C +60° C	-20° C +60° C
thermal switch	140° C	-	-
limit switch	2 opening and closing	No	2 opening and closing
irreversible automated devices	YES	YES	YES
operator weight	11,1 kg	11,1 kg	11,1 kg

Application diagram



Installation positions

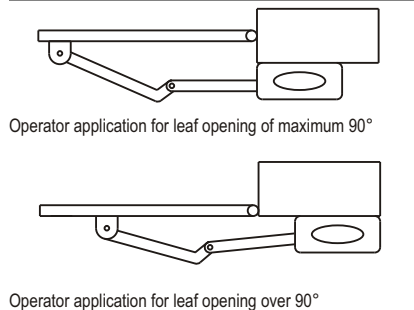

Dimensions

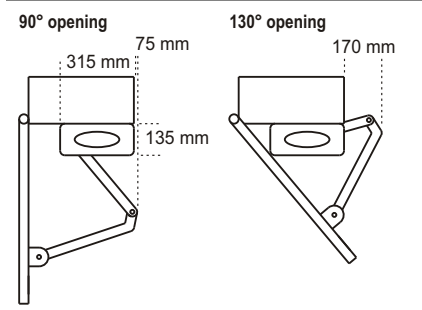

ART

Electromechanical operators with articulated arm for swing gates

The ART series allows installation also in particular conditions, for example, where there are large pillars.

The special fastening plate makes installation fast and easy.

ART incorporates the opening and closing limit switches and the unlocking device for emergency manoeuvres (an accessory is also available for

wall mounting the device with the key selector function).

In the 12 VDC and 24 VDC versions it can be integrated with the optional battery kit which allows opening and closing the gate even in the event of a blackout, as well as achieving the highest level of safety against crushing as required by the EN 12453 standards.





ART

		Package Pieces	Pieces per pallet	Kg	Code	€
1A	ART5000	With opening and closing limit switches	1	30	338	30510 446,50
	ART5012		1	30	338	30512 554,91
1B	ART5024	With opening and closing limit switches	1	30	338	30524 540,00

Articulated arm not included

Accessories



30900
Articulated arm
425 x 460 mm
€ 82,64



50139/NEW
Long reinforced articulated arm for large pillars (600 x 540 mm)
€ 138,18



12550
1 1.9 Ah battery (12 V)
2 batteries are required for 24V
€ 51,03



12560
6.5 Ah battery kit in IP55 case (for ART3012)
€ 93,14



A90792P
IP55 case for batteries and boards complete with battery fastening brackets
€ 23,49



AJ00608
24 V battery charger board
€ 58,45



AJ00310
ART external unlocking device kit, also with key selector function
€ 97,80

Recommend control units for ART 5000:
AS04180 (F4 PLUS)
AS05040 (BA 230)
AS05060 (BA 100)
Pages 74 - 75 - 76

Recommend control units for ART 5012:
AS04220 (F12 RALLY)
AS04340 (F12 E)
Pages 79 - 80

Recommend control units for ART 5024
AS05100 (BA 24)
Page 77







Electric lock
See page 105

ART 5000 KIT

											Package Pieces	Pieces per pallet	Kg	Code	€
Kit ART5000	2x 1A	1x 2A	2x 3	1x 4	1x 5	1x 6	1x 7	1x 8	1x 9		1	12	526	K351/08/F1	1.386,00
Kit ART5000	2x 1A	1x 2A	2x 3		1x 5	1x 6		1x 8	1x 9		1	12	526	K351/08/Z1	1.323,00
Kit ART5024	2x 1B	1x 2B	2x 3	1x 4	1x 5	1x 6	1x 7	1x 8	1x 9		1	12	526	K354/08/F1	1.688,40
Kit ART5024	2x 1B	1x 2B	2x 3		1x 5	1x 6		1x 8	1x 9		1	12	526	K354/08/Z1	1.618,00
Kit ART5000	2x 1A	1x 2C	2x 3	1x 4	1x 5	1x 6	1x 7	1x 8	1x 9		1	12	526	K355/08/F1	1.440,00
Kit ART5000	2x 1A	1x 2C	2x 3		1x 5	1x 6		1x 8	1x 9		1	12	526	K355/08/Z1	1.370,00

As well as the operators the kit contains :

<p>2A</p>  <p>AS04180 (pour ART 5000) Control unit F4 PLUS</p>	<p>2B</p>  <p>AS05100 (pour ART 5024) Control unit BA 24</p>	<p>2C</p>  <p>AS05040 (pour ART 5000) Control unit BA 230</p>	<p>3</p>  <p>AS30900 Articulated arms</p>	<p>4</p>  <p>Complete flashlight</p>	<p>5</p>  <p>Radio receiver board</p>	<p>6</p>  <p>AU03000 DOMINO radio control DTS4334 - 433 MHz</p>
<p>7</p>  <p></p> <p>AU01940 Wall-mounted key selector DCS100</p>	<p>8</p>  <p>AU02000 Pair of wall-mounted photocells DCF 180</p>	<p>9</p>  <p>A758000 Warning plate</p>				